

BASE

Custom Made Awnings

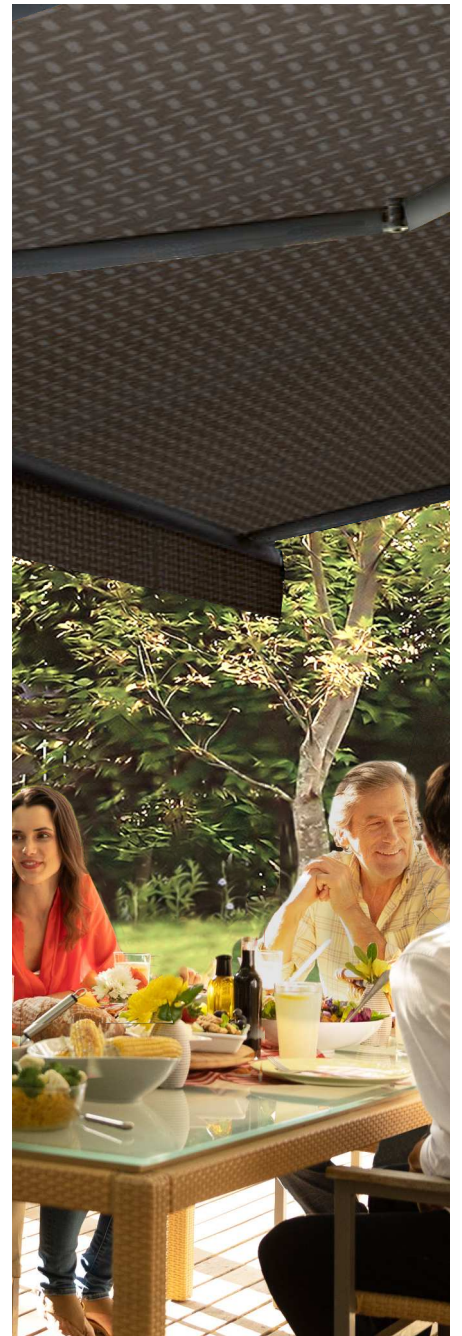



CONTENTS

Base Plus	Page 5
Base Lite	Page 7
Armony Plus	Page 9
Calnova	Page 11
Zenith	Page 13
Qubica Light	Page 15
Italia Slim	Page 17
Motorisation	Page 19
Lighting and Heating	Page 21
Brackets and Supports	Page 24
Designer fabrics	Page 26



Awnings Collection

Our Folding Arm Retractable Awnings offer the best in open-plan outdoor living. We offer solutions for small terraces to large outdoor entertaining areas.

Plus our commercial awnings can be fully customised, to suit the needs of business from retail to hospitality.



Custom made in the UK

We supply bespoke awnings made to the exact specifications and high quality that our customers require.

We have a close association with BAT who, for over 35 years, have been designing and manufacturing systems and components for, cassette awnings and pergolas.

Base Plus

Fully cassetted folding arm awning





THE BASE PLUS is a fully cassetted folding arm awning on two brackets fitted at either end top of face fixed.

Our most popular awning, operated manually or motorised, is suitable for both domestic and commercial applications. It features a stainless steel chain link arm in four different sizes with or without adjustable ambient LED lighting to suit your application needs.

Supplied fully set up for a quick and easy installation the innovative design is equipped with an inclination system that uses a pass-through screw to adjust the pitch to your exact needs.

Colours RAL

9010 White (Standard)

7016 Grey ●

Min/Max width

Minimum 1910mm

Maximum 5500mm

Minimum width to accommodate arm size

Projection (CM)	Width (CM) 2 brackets
160	191
210	241
260	291
310	341

Optional LED Arms



Installation

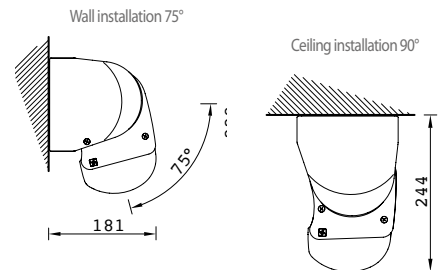
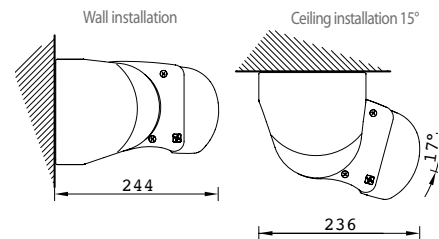

Base Lite

Fully cassetted folding arm awning





BASE LITE as the name suggests is a core part of the Base Family, built to replicate the base plus but in smaller proportions.

This Fully cassetted system is a fantastic addition to any property, whether extending the home with a welcome shaded area to your garden patio or protecting your shop window from light showers or a dazzling sunshine glare.

Due to its tight and compact finish the base plus accommodates a width up to 4m with three different projections in arm length.

Available top or face fixed with a bracket at either end a quick and easy install is easy to achieve with a simple adjustment to the pitch with a screw in system.

Colours RAL

9010 White (Standard)

Min/Max width

Minimum 1910mm
Maximum 4000mm

Minimum width to accommodate arm size

Projection (CM)	Width (CM) 2 brackets
160	191
210	241
260	291

Installation

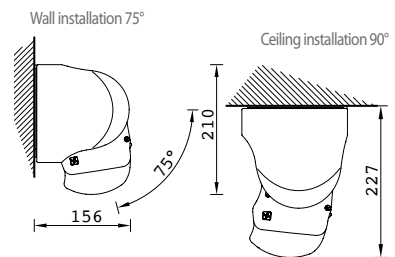
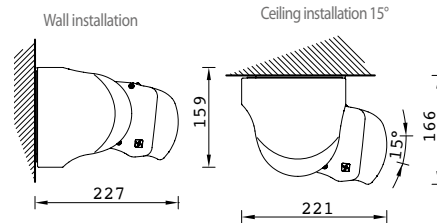

Armony Plus

Fully cassetted folding arm awning



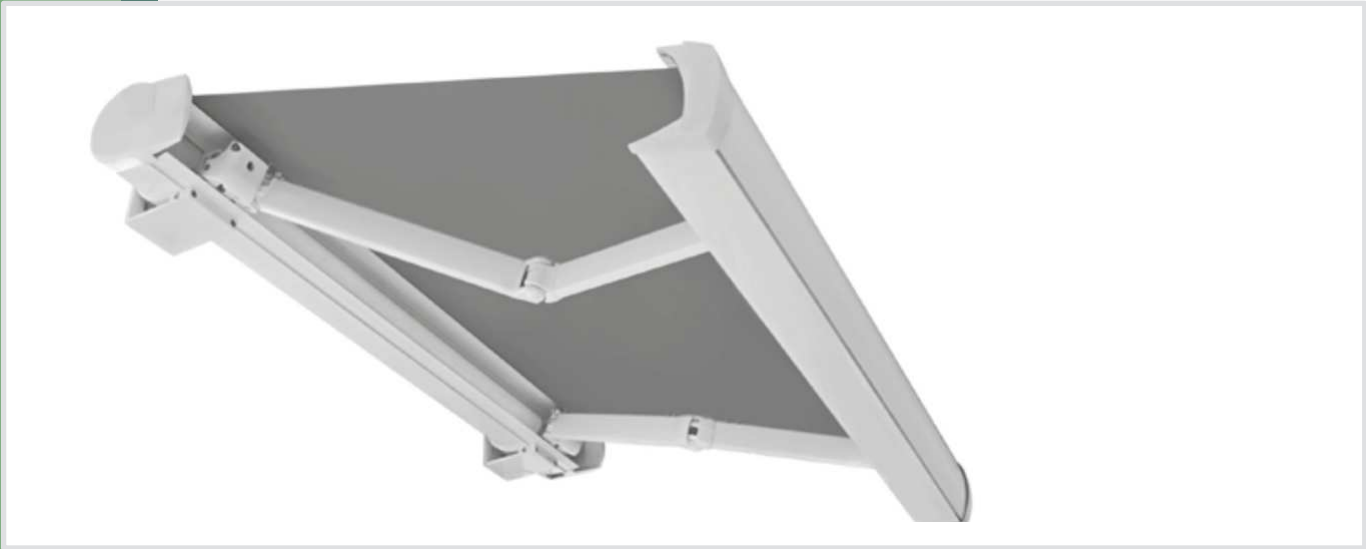

THE ARMONY PLUS incorporates design and style into a fully cassetted system, whilst retaining its strength through an impressive and innovative multi bracket fixing system along the length of the Awning.

This system lends itself to larger applications, supplied up to 7M in one length and a massive 12m with a seamless profile join for an onsite build up. Not only does this Awning accommodate large widths, but a more than impressive 5 projections up to 3.6m with or without incorporated LED lights.

This carefully put together combination of design features makes it our most popular system for Commercial applications along with large domestic applications.

Colours RAL

9010 White (Standard)

Min/Max width

Minimum 2120mm
Maximum 12000mm

Minimum width to accommodate arm size

Projection (CM)	Width (CM) 2 brackets
160	212
210	262
260	312
310	372
360	431

Optional LED Arms



Installation

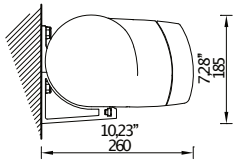

Wall installation

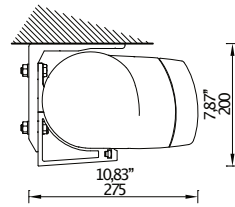

Ceiling installation



Calnova

Semi cassetted folding arm awning





As our newest addition we are excited to introduce the CALNOVA to our range of products. Calnova boasts a steel square back bar system providing a strong and flexibility fitting method either top or face fix.

The Semi Cassetted design accommodates the fabric for protection all year round when retracted, whilst the patented tipping system allows adjustment to the Awning pitch when extend out to one of its 5 available projections.

Colours RAL

9010 White (Standard)

Min/Max width

Minimum 2100mm
Maximum 12000mm

Minimum width to accommodate arm size

Projection (CM)	Width (CM) 2 brackets
160	210
210	260
260	310
310	360
360	410

Installation

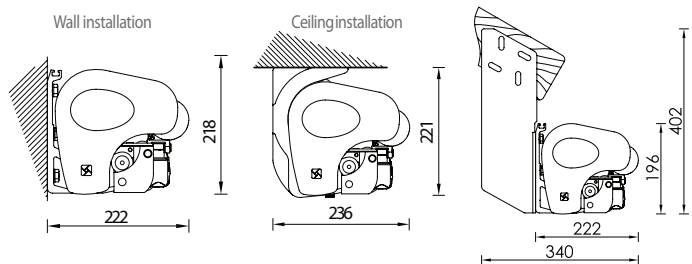

Optional large front rail

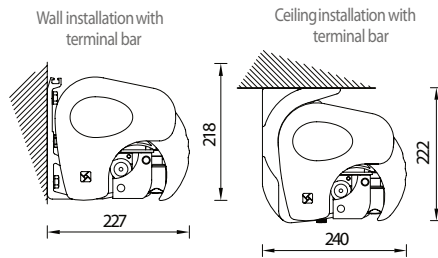

Large front rail

Optional LED Arms



Arms (A) Wall brackets (W)

Width (CM)	400		500		600		700		800		900		1000		1100		1200	
	A	W	A	W	A	W	A	W	A	W	A	W	A	W	A	W	A	W
160	2	3	2	3	2	4	4	4	4	5	4	5	4	6	4	7	6	8
210	2	3	2	3	2	4	4	4	4	5	4	5	4	6	4	7	6	8
260	2	3	2	4	2	4	4	4	4	5	4	5	4	6	4	7	6	8
310	2	3	2	4	2	6	3	6	4	7	4	7	4	8	4	8	6	9
360	-	-	2	4	2	6	3	6	3	5	4	7	4	8	4	8	6	9



Zenith

Fully cassetted folding arm awning





ZENITH is a retractable awning with a fully closing cassette on a rectangular bar 50x30mm. Functional and reliable this awning gets tipping system (BAT patented) brackets that enables a complete perfect closing of the front bar even at maximum inclinations.

Colours RAL

9010 White (Standard)

Min/Max width

Minimum 2220mm
Maximum 12000mm

Optional LED Arms



Installation

Wall installation

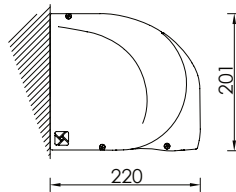

Ceiling installation

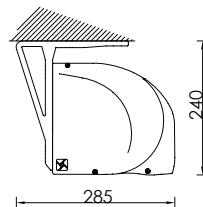

Minimum width to accommodate arm size

Projection (CM)	Width (CM) 2 brackets
160	222
210	272
260	322
310	372
360	431
410	481
435	506

Arms (A) Conveyor (C) Square bar bracket (S)

Width (CM)	400			500			600			700			800			900			1000			1100			1200		
Projection (CM)	A	C	S	A	C	S	A	C	S	A	C	S	A	C	S	A	C	S	A	C	S	A	C	S	A	C	S
160	2	3	5	2	3	5	2	3	6	4	4	8	4	4	8	4	5	8	4	5	11	4	6	11	6	6	12
210	2	3	5	2	3	5	2	3	6	4	4	8	4	4	8	4	5	8	4	5	11	4	6	11	6	6	12
260	2	3	5	2	3	5	2	3	6	4	4	8	4	4	8	4	5	8	4	5	11	4	6	11	6	6	12
310	2	3	5	2	3	5	2	3	6	4	4	8	4	4	8	4	5	8	4	5	11	4	6	11	6	6	12
360	-	-	-	2	3	5	2	3	6	3	4	8	3	4	8	4	5	8	4	5	11	4	6	11	4	6	12
410	-	-	-	2	3	5	2	3	6	2	4	6	3	4	8	3	5	8	4	5	11	4	6	11	4	6	12
435	-	-	-	-	-	-	2	3	6	2	4	7	3	4	8	3	5	8	3	5	8	4	6	11	4	6	12

Qubica Light

Fully cassetted folding arm awning





Our widest end fix awning, the QUBICA LIGHT is an innovative and modern design spanning widths up to 6m.

Standing out from the crowd, the simplistic inset section of the front rail wraps into the cassette, customisable in four colour combinations completely hiding the fixing elements

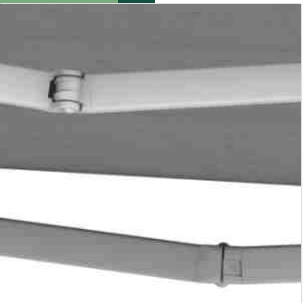
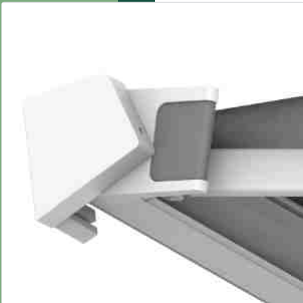

Min/Max width

Minimum 1900mm
Maximum 6000mm

Minimum width to accommodate arm size

Projection (CM)	Width (CM) 2 brackets
160	190
185	221
210	246
235	271
260	296
310	346
360	396

Colours RAL

- 9010 White (Standard)
- 9006 Aluminium
- Carbon
- Corten

Colour Combinations: Carbon (CARB), Corten (CORT)

C1	C2	C3	C4	C5	C6	C7	C8	C9	C10BA	C11	C12	C13	C14	C15	C16
9010	9010	9010	9010	9006	9006	9006	9006	CARB	CARB	CARB	CARB	CORT	CORT	CORT	CORT
9010	9006	CARB	CORT	9006	9010	CARB	CORT	CARB	9010	9006	CORT	CORT	9010	9006	CARB

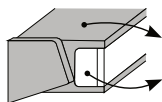

Installation

Ceiling installation

Ceiling installation 80°

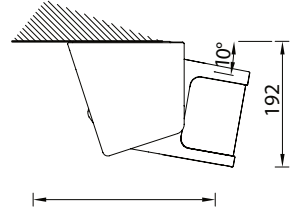
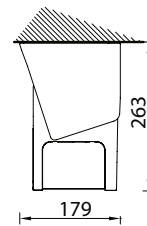

Optional LED Arms



Italia Slim

Drop arm awning



BASE



The ITALIA SLIM uses spring loaded arms to ease the fabric back into the fully enclosed cassette.

The operation of the awning is both smooth and effortless.

As the awning closes, the sculptured bottom rail fits snugly into the top cassette box, to form a weather-proof enclosure to protect the fabric.

Colours RAL

9010 White (Standard)
9006 Aluminium

Min/Max width

Minimum 1200mm
Maximum 4000mm

Installation

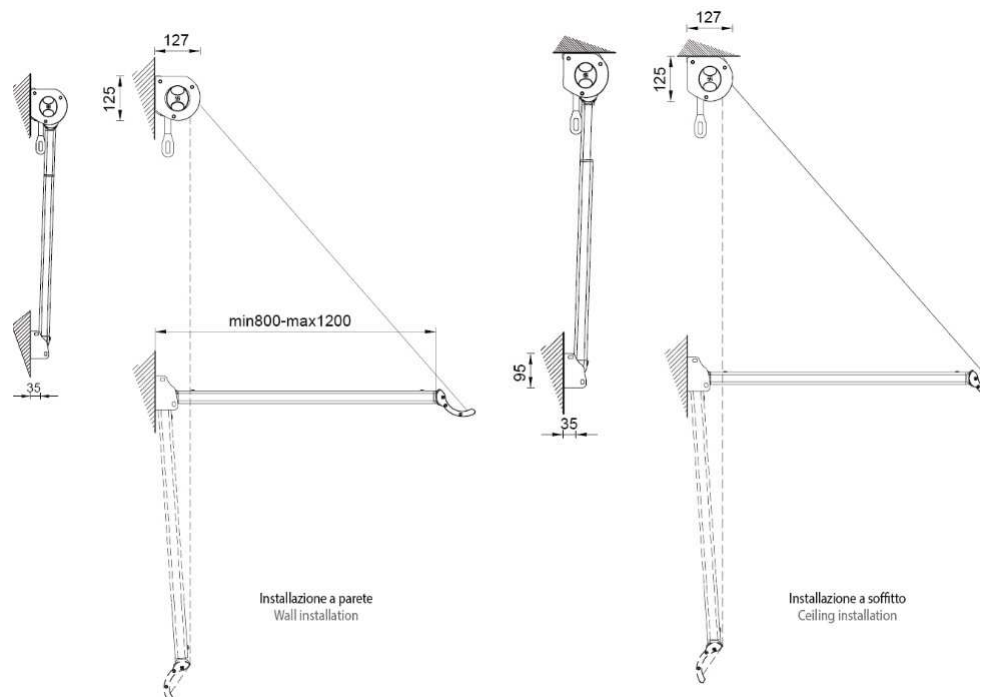

Motorisation

Enjoy your awning with ease





Motorisation

Somfy motors makes awnings electrically operable. Their motors are suitable for installation on most available manual awnings, and can also be integrated directly into a new tailor-made sun shade.

We have a wide range of motors, each with their specific properties and areas of application.



Somfy IO Motor



Situ 1 IO (single channel remote)



Situ 5 IO (5 channel remote)



Smoove IO Wall Mounted Switch



Situ Variation Anemometer IO (1 channel remote)



Situ Variation Anemometer IO (5 channel remote)



Soliris IO Mains Powered, Wireless Sun & Wind Sensor

Controls sun protections on the basis of the measured amount of sunlight and wind speed up and down.



Eolis IO Wind Sensor
Battery Powered

Automatically controls awnings upwards based on the measured wind speed.



Eolis 3D Wirefree IO Anemometer Wind Sensor
Battery Powered



Eolis 3D Vibration Sensor
Battery Powered (White/ Black)

Lighting and Heating

Extend your outdoor entertaining into the evening with LED Lights and Infrared Heaters.





Lighting

Lighting is the missing touch to an awning you never knew you needed. Awnings designed to provide shelter from the Sun during the day, also create a warm atmospheric environment to sit under in the evening; whether enjoying a drink with friends or a meal with family, our adjustable LED lighting strips incorporated into the arms can also dim to 50% brightness.

LED lights built into the awning arms



Available on Base Plus and Armony Plus models

LED lighting receiver



Somfy io-home control.



All LED light arms are supplied with an external electrical box to house the receiver and transformer along with a wiring diagram.

Dimensions:
254mm Wide x 180 deep
x 90mm high



The Rio Grande s a fully weatherproof infrared heater used in all seasons, and comes with a safety guard fitted as standard.

This popular weatherproof infrared heater comes with a two year manufacturer's warranty and is a must have for any wholesaler, contractor and distributor wanting to add one of the best infrared heaters available on the market to their range.

Installation of the Rio Grande Single couldn't be easier and comes as standard, with a central 'swivel' bracket that allows you to mount the heater horizontally or at an angle. The Rio Grande Single produces radiant heat just like the sun, directly warming people and objects rather than the air in between.

Rio Grande Single and Double



- Heat Coverage Area 12m sq.
- Available in any RAL colour
- 1.5kW - 2.0kW
- 2.8kg

Technical

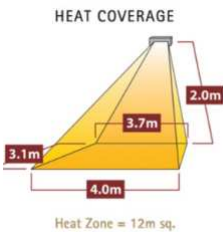

TECHNICAL DATA

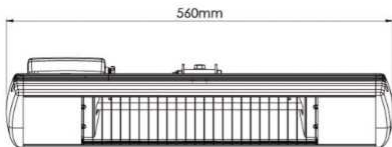

Accessories

A wide selection of switches and heater controls that are suited to almost any situation and need.

Where energy and cost savings matter, we don't believe in heating an empty space or having more heat than is required.

Operated through your Somfy Awning remote or combined with a touch/ presence timer, our ambient range can be adjusted to ensure energy efficiency whilst ensuring maximum user comfort and energy savings.



Brackets and Supports





Brackets

- All Awnings are supplied with brackets as standard.
- We can supply a range of different brackets all zinc and powder coated for your awning fitting requirements.
- We uphold and ensure all our Brackets meet UK/ CA/CE standards.

Pipe Bracket



Safe and compact brackets for installing around wastewater pipes.

The critical dimension always to check is from the back of the wall to the front of the obstruction.

We recommend that the projection exceed 300mm.

Gutter Bracket



The Gutter Bracket is designed to be the perfect solution for low installation heights and to overcome obstructions which can arise when fitting awnings to bungalow roof lines or above outward opening doors where additional height is required.

Spreader Plate



Standard fixing for single storey extensions and load-bearing applications.

Designed to spread the load away from the top of the wall on a single storey extension.

Designer fabrics from





Although Dickson awning fabrics are primarily designed to provide effective protection from UV rays and heat, thanks to their unique coating, Dickson fabrics also afford protection against short showers and light rain.

Additionally, they are able to protect the awnings from the elements by preventing water and dirt penetration

They are the ideal complement to exceptional spaces in cities, the countryside or at sea, they protect from natural hazards such as pollution, stains, sun damage and mold.

Both technically advanced and highly decorative, the fabric collections developed by the Dickson® Design department are in tune with the latest trends.

There is a comprehensive range of styles, colours and textures, you can choose from and whatever your specific wishes and needs, our team will be able to advise you on the most suitable solutions..

View all the fabric available online at www.dickson-constant.com/en/solar-protection.html

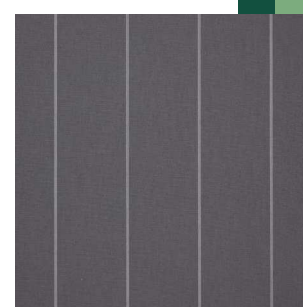
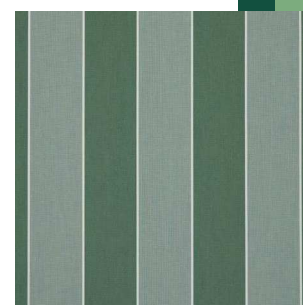



Custom Made Awnings

Base Direct Awnings and Blinds Ltd.

Unit 2B Masonry Trading Estate, 135A Bloxwich Road, Wallsall, West Midlands. WS2 8BS

www.basedirect.co.uk